



## SHIPPING

Please communicate with the distributor about the transportation before returning the equipment, so as to ensure that the equipment can directly reach the maintenance center.

THE SERVICE CENTER DOES NOT PROVIDE PICK-UP SERVICE.  
PLEASE BE SURE TO USE THE ORIGINAL PACKAGING TO ENSURE  
THAT THE EQUIPMENT WILL NOT CAUSE TRANSPORT DAMAGE.

# PL-audio

PL-audio GmbH & Co. KG  
Siegener Str. 6  
57482 Wenden - Germany

## D-SERIES

### HIGH-END PROFESSIONAL AUDIO POWER AMPLIFIER

DIGITAL AMPLIFIER

This manual does not include all of the details of design, production, or variations of the equipment.  
Nor does it cover every possible situation which may arise during installation, operation or maintenance.

**READ THESE INSTRUCTIONS BEFORE UNPACK**

### Power parameter

### D2

2X3000W	2 Channel Mode			Bridge Mode	
EIAJ Test Standard, 1 kHz, 1% THD	8Ω/CH	4Ω/CH	2Ω/CH	8Ω	4Ω
	3000	4500	6000	9000	12000
Maximum Output Voltage/Current	185V/85A			370V	

### Power parameter

### D4

4X2000W	4 Channel Mode			Bridge Mode	
EIAJ Test Standard, 1 kHz, 1% THD	8Ω/CH	4Ω/CH	2Ω/CH	8Ω	4Ω
	1600	2500	3500	4500	6000
Maximum Output Voltage/Current	185V/85A			370V	

### Power parameter

### D4.8

4X2000W	4 Channel Mode			Bridge Mode	
EIAJ Test Standard, 1 kHz, 1% THD	8Ω/CH	4Ω/CH	2Ω/CH	8Ω	4Ω
	2000	3000	4500	6000	9000
Maximum Output Voltage/Current	185V/85A			370V	

■ IF THE POWER CORD IS DAMAGED, PLEASE GET A REPLACEMENT FROM THE DISTRIBUTOR. OTHERWISE, CONTINUED USE OF THE EQUIPMENT MAY LEAD TO FIRE OR ELECTRIC SHOCK.

■ IF THE DEVICE FALLS FROM A HEIGHT OR THE SHELL IS DAMAGED, PLEASE IMMEDIATELY TURN OFF THE POWER SWITCH AND UNPLUG THE POWER PLUG. AND CONTACT THE AGENT DEALER TO SOLVE THE PROBLEM.

■ WHEN ANY ABNORMALITY OCCURS, SUCH AS SMOKE, ODOR, ETC. PLEASE TURN OFF THE POWER SWITCH IMMEDIATELY AND UNPLUG THE POWER PLUG TO CHECK THE PROBLEM. AT THE SAME TIME, PLEASE CONTACT THE DISTRIBUTOR TO CHECK THE REASON FOR THE ABNORMALITY.

■ TO PREVENT ELECTRIC SHOCK DO NOT REMOVE TOP OR BOTTOM COVERS.

■ THE EQUIPMENT IS ONLY TESTED AND EVALUATED AT THE HIGHEST ALTITUDE OF 2,000 METERS.

*All information provided in this manual is accurate at the time of delivery. Due to version change or design change, it cannot be timely notified. The latest information can be obtained of contacting the distributor.*

### Notice these symbols:



The exclamation point triangle symbol prompts the user for important operation and maintenance instructions.



Lightning, or the lightning triangle symbol, warns the user of the risk of electric shocks.

### DESIGN CHANGES

WE RESERVE THE RIGHT TO CHANGE THE DESIGN OF ANY PRODUCT FROM TIME TO TIME WITHOUT NOTICE AND WITH NO OBLIGATION TO MAKE CORRESPONDING CHANGES IN PRODUCTS PREVIOUSLY MANUFACTURED.



# Performance parameter

Alternating Current Power Supply				
Power	PFC Power			
Rated power demand	100-240 V $\pm$ 10%, 50/60 Hz			
Operation voltage	90V-270V			
Power correction factor cos ( $\varphi$ )	>0.95 @ >500 W			
Standby	47W	0.8A	47W	0.8A
Temperature				
Environment temperature	0°- 45C / 32°-113°F			
Cooling system	Tunnel through cooling system			
Performance				
Frequency Response	20 Hz - 20 kHz (1 W @ 8 $\Omega$ , $\pm$ 0.5 dB)			
Signal-to-Noise Ratio	>110 dBA (20 Hz - 20 kHz, A weighted)			
Crosstalk	> 66 dB @ 1 kHz			
Input Impedance	10 k $\Omega$ balanced			
Total Harmonic Distortion (THD)	<0.5% from 1 W to full power (Typical value<0.05%)			
Intermodulation Distortion(IMD)	<0.5% from 1 W to full power (Typical value<0.05%)			
Damping Factor (8 ohms)	>5000 @ 20-200 Hz			
Slew Rate	50 V/ $\mu$ s @ 8 $\Omega$			
Front Panel				
Indicator LED/per channel	One PCS Green LED: the input signal of XLR $\geq$ -40dB;			
	Four pieces Green LED: display the output signal (-20dB, -10dB, -5dB, -3dB) of SPEAKON			
LED Screen	1 piece dual LED (Yellow and Red): Protective state/Clip state/Over heat/Over load			
	1.Display per channel operation mode: Mono mode, Bridge mode and Stereo mode; Display the temperature of the equipment the device turns on protective state, and the temperature of the equipment > 75°C;			
Power Switch	Press "I" -on; Press "O" -off.			
Dust-proof	Two pieces dust-proof cotton, it can take off to clean from the bottom of front panel			
Application				
Signal in-connection	4 Channel: One balanced XLR(with lock) female per channel; 2 Channel: One balanced XLR(with lock) female and one balanced XLR male per channel.			
Signal out-connection	One SPEAKON per channel connect to loudspeakers			
Power cord	Fixed to the device, and the CSA(cross sectional area) of the cord is 3 x 2.5mm <sup>2</sup> , and the cord is 1.5 meters long.			
Multiple-Functions Switch	Two Sensitivity Switches, one Mode Switch and one Clip Switch.			
Structure				
Dimensions	482x44x470mm <sup>3</sup>			
Net weight	12Kg			
Packing size	580x580x116mm <sup>3</sup>			
Shipping weight	14Kg			

# Rear panel Features

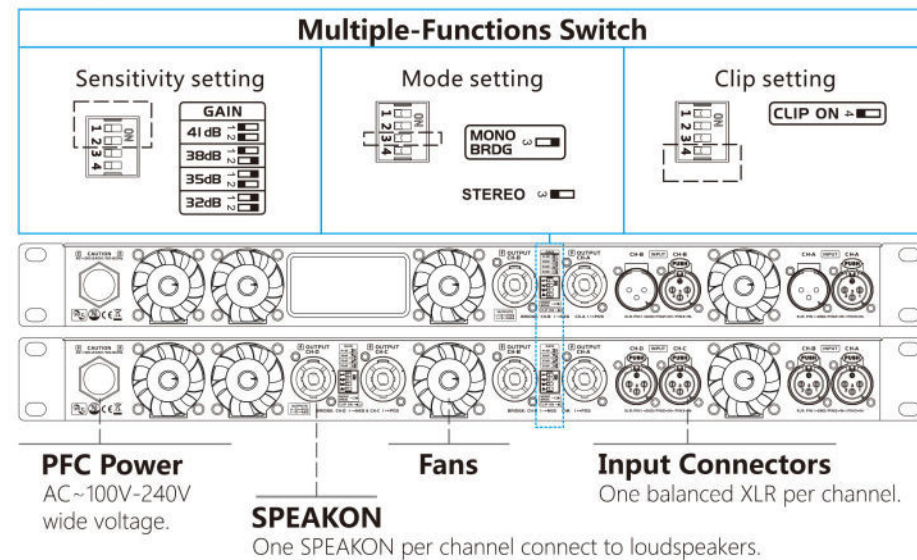

# Dimensions and cooling system

NOTE:  
The size is 437mm inside of the device(without the cover plate and front panel).  
The size is around 472mm of the complete device, but a little bit different size in the different front panel.

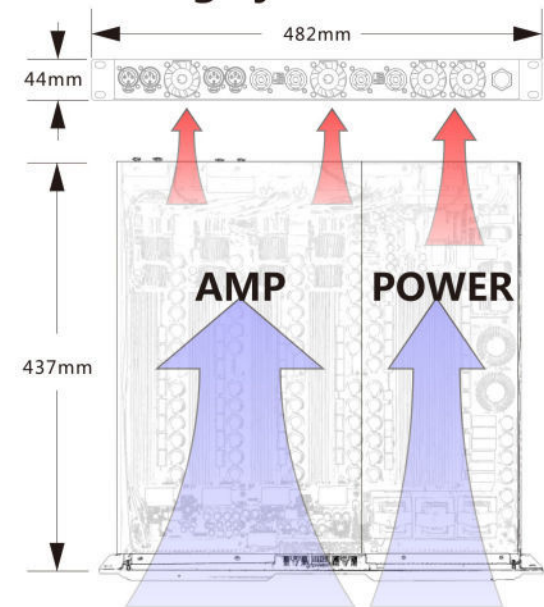

# Tunnel through cooling system

Cold air comes in from the front panel of the equipment, forms a duct through the radiator to take the heat away and out from the rear panel of the equipment.

# Application introduction

## 2 channel Series

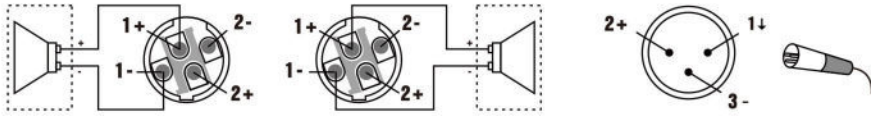

### STEREO MODE

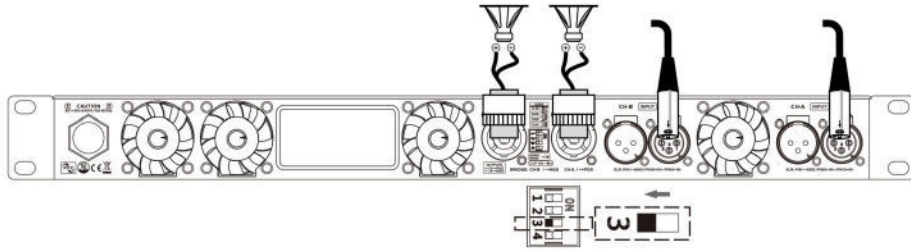

### BRIDGE MODE

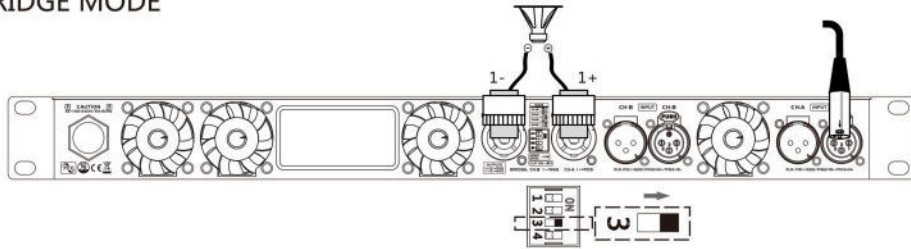

### MONO MODE

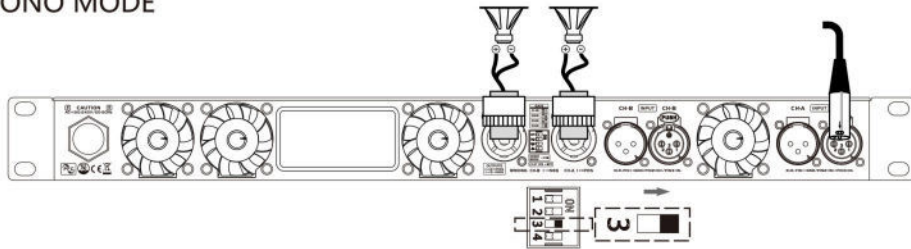

## 4 channel Series

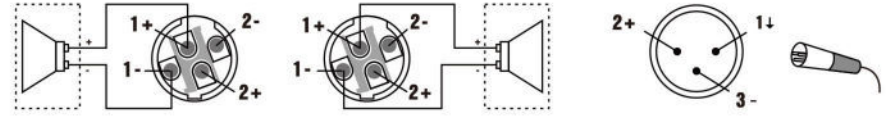

### STEREO MODE

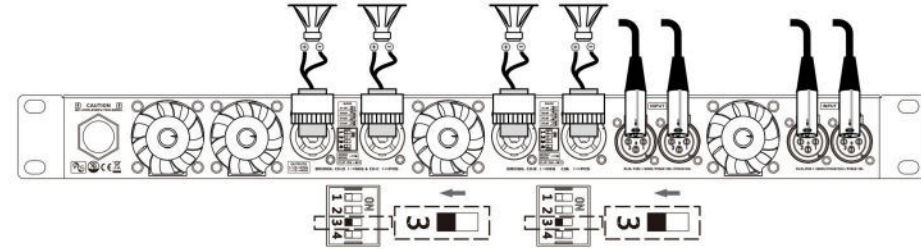

### BRIDGE MODE

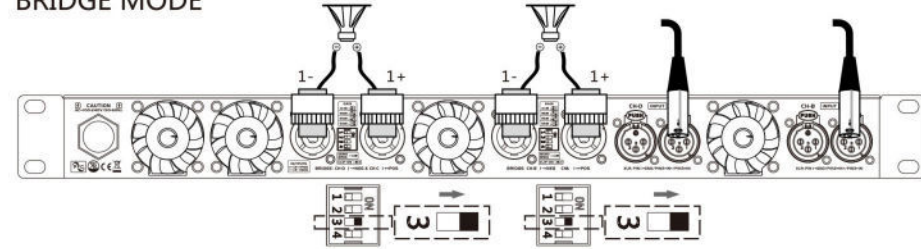

### MONO MODE

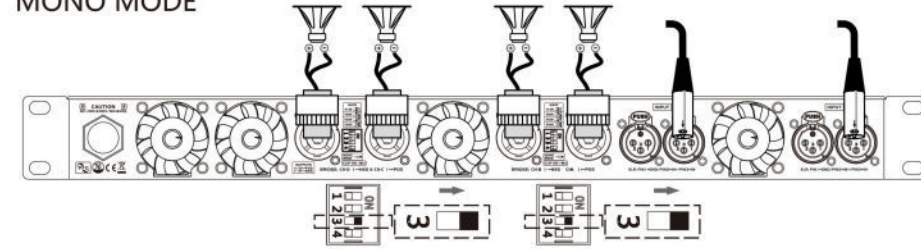

# Front panel Features

*Note: For the convenience of introducing the front panel, this schematic diagram is a simplified schematic diagram after removing the exterior decorative panel. Due to the change of version, it may be inconsistent with the real thing, please refer to the product. The vent area and layout of this product have been strictly tested of experiments to meet the cooling needs. Please make sure not to block the vent during use.*

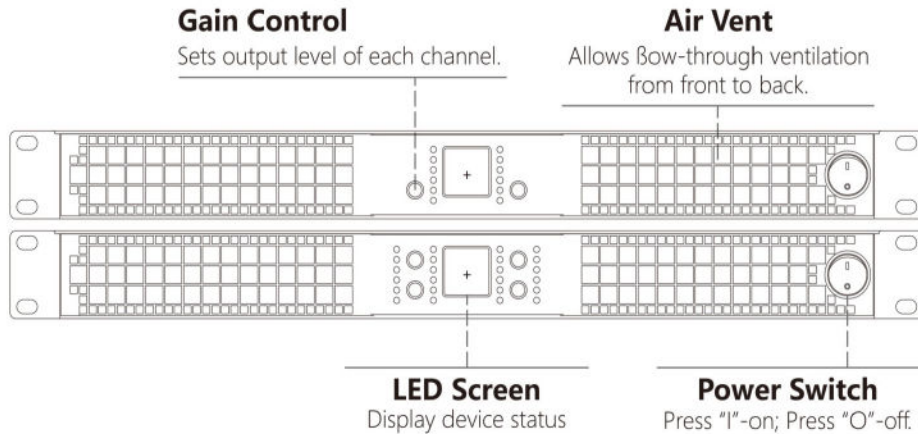

# PL-audio



## Dual Signal LED

The red LED turns on: This channel turn on protective state, stop working. Please wait for around a minute, if the device still stops working, please restart the device.

The yellow LED f lashes: This channel signal is audibly distorting. It may damage the tweeter.

The yellow LED turns on:

- 1.The temperature of the equipment  $\geq 70^{\circ}\text{C}$ ;
- 2.The signal over load.

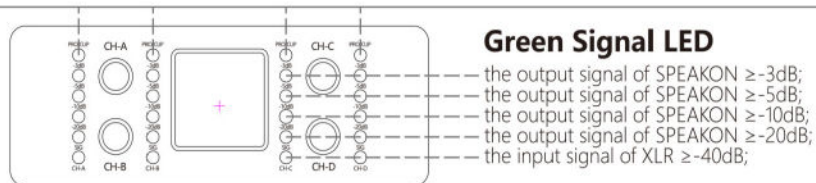

## Green Signal LED

- the output signal of SPEAKON  $\geq -3\text{dB}$ ;
- the output signal of SPEAKON  $\geq -5\text{dB}$ ;
- the output signal of SPEAKON  $\geq -10\text{dB}$ ;
- the output signal of SPEAKON  $\geq -20\text{dB}$ ;
- the input signal of XLR  $\geq -40\text{dB}$ ;

CH-A CH-B MONO/BRIDGE 69.0°C NORMAL STATE	CH-A CH-B MONO/BRIDGE CH-C CH-D MONO/BRIDGE 69.1°C OVERHEAT WARNING	CH-A CH-B MONO/BRIDGE CH-C CH-D MONO/BRIDGE 75.1°C PROTECTION
--	--	--



## LED Screen

1.Display per channel operation mode: Mono mode, Bridge mode and Stereo mode;

2.Display the temperature of the equipment:

Green : the normal status, and the temperature of the equipment  $< 69^{\circ}\text{C}$ ;

Orange: the warning of overheat, and the temperature of the equipment between  $69^{\circ}\text{C}$  and  $75^{\circ}\text{C}$ ;

Red: the device turns on protective state, and the temperature of the equipment  $> 75^{\circ}\text{C}$ ;

# **IMPORTANT SAFETY INSTRUCTIONS**

1. Read these instructions before unpack.
  - ◆ Keep these instructions.
  - ◆ Heed all warnings.
  - ◆ Follow all instructions.
  - ◆ Please keep the accessories (such as feet, instructions, desiccant and plastic bags) away from children.
  - ◆ The packaging of the equipment is guaranteed of the drop test, ensuring that the original packaging is used in the transportation.
2. The installation operation.
  - ◆ Do not use this apparatus near water.
  - ◆ Do not block any ventilation openings.
  - ◆ Do not install near any heat sources.
  - ◆ Do not damage the safety function of the device with the polarity plug or grounding plug.
  - ◆ Protect the power cord from being walked on or pinched, particularly at plugs, convenience receptacles, and the point where they exit from the apparatus.
  - ◆ Unplug this apparatus during lightning storms or when unused for long periods of time.
  - ◆ Do not expose this equipment to dripping or splashing and ensure that no object filled with liquids.
3. Use equipment
  - ◆ Please make sure to turn the volume control knob to the minimum before turning on the power of the device. Otherwise, sudden bursts of sound may damage your hearing.
  - ◆ Please avoid using the equipment on unstable surfaces or bevels.
  - ◆ Please avoid using the equipment in the environment with high air humidity or dust accumulation.
  - ◆ Please avoid using the equipment in an overheated environment.
  - ◆ When connecting to the device, turn off all audio devices and speakers.

**PL-audio**

# **WARRANTY**

## **SUMMARY OF WARRANTY**

The warranty period provided by our company is one year (The warranty period is calculated from the purchase date of the original purchaser). During the warranty period, you can obtain the free maintenance if the product material and process caused by the problem.

## **WHAT THE WARRANTOR WILL DO**

We will remedy any defect, regardless of the reason for failure (except as excluded), by repair, replacement. Warranty work can only be performed at our authorized service centers or at the factory.

## **WHAT SITUATION INVALID BY THE WARRANTY SERVICE**

- Exceeds warranty period posterior product.
- The warranty does not cover any product which has been damaged because of any intentional misuse, accident, negligence, or loss which is covered under any of your insurance contracts.
- This Warranty also does not extend to the new product if the serial number has been defaced, altered, or removed.
- The equipment has been repaired or modified by people who does not belong to our company.
- The equipment broken in case of force majeure such as earthquake and fire, etc.
- Damage in transit caused by not using the original packaging, such as scratches, deformation or falls.

## **SUMMARY OF NON-WARRANTY SERVICE**

The company provides paid maintenance services for products that have passed the warranty period. We'll show you the test report. And we will not start the repair until we get your approval and receive the cost for replacement parts. If you do not agree to repair, please take back the equipment.

THE COMPANY HAS NO OBLIGATION TO KEEP YOUR EQUIPMENT. IF THE EQUIPMENT IS NOT TAKEN BACK WITHIN 30 DAYS WITHOUT SPECIAL REASONS, THE COMPANY SHALL HAVE THE RIGHT TO DISPOSE OF IT AT ITS OWN DISCRETION.